



# دوره آموزشی AutoCAD

محیط سه بعدی

مهدی متقی پور

عضو هیأت علمی دانشگاه صنعتی شریف

Www.sharifcadcam.ir

Sharifcadcam@gmail.com

@sharifcadcam

021-66980854

021-66980926

این جزوه متعلق به موسسه شریف کد کم می باشد. کپی و نشر تمام و یا بخشی از آن غیر قانونی است.

تنها افرادی مجاز به استفاده از این جزوه هستند که دوره آموزشی اتوکد دوبعدی را از سایت [sharifcadcam.ir](http://sharifcadcam.ir) خریداری کرده اند.

## جلسه اول

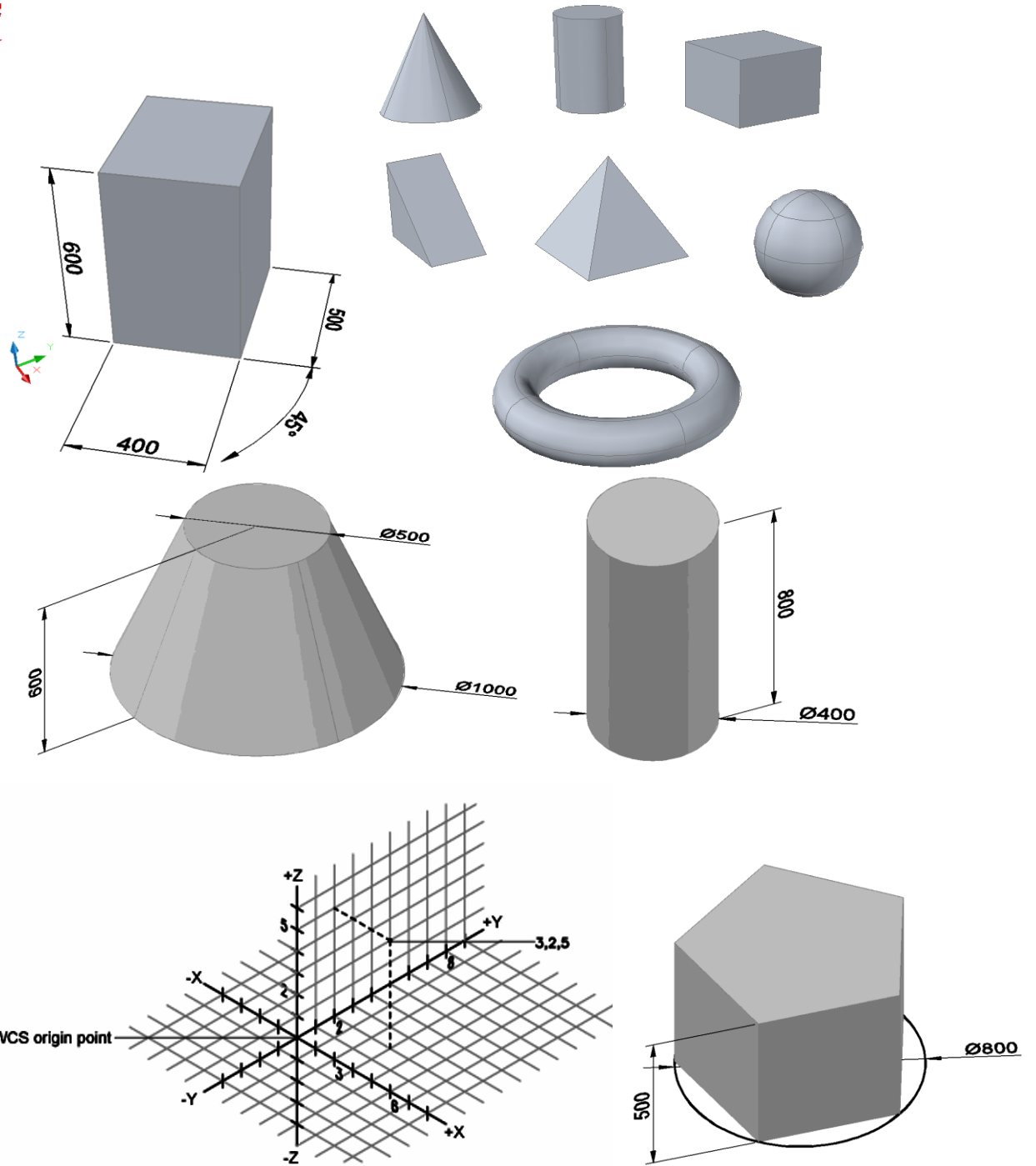

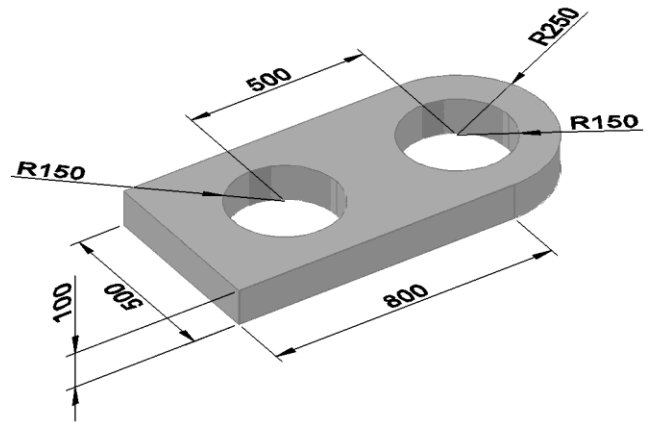
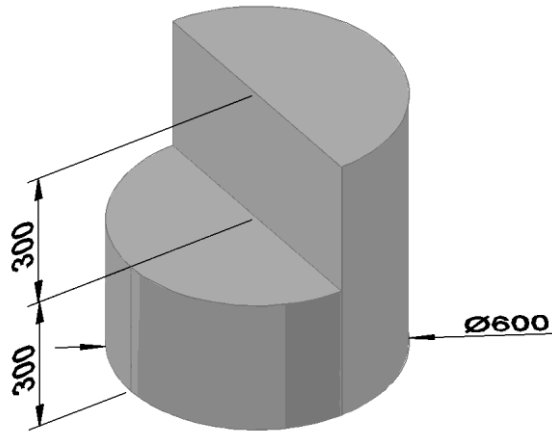
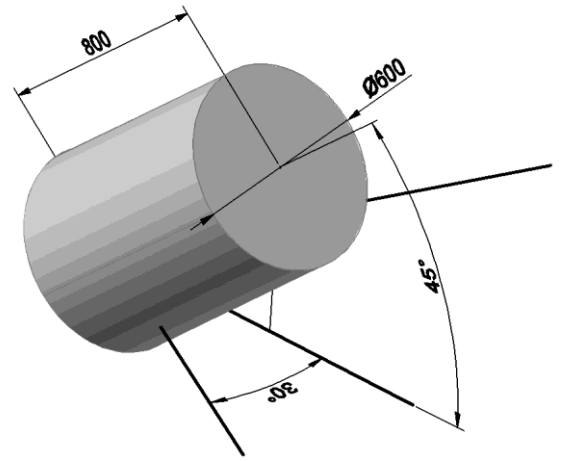
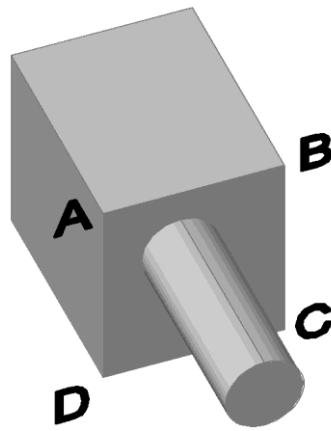
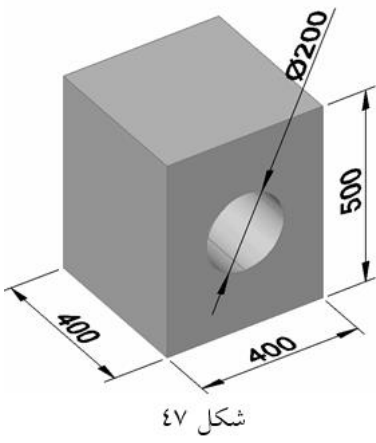
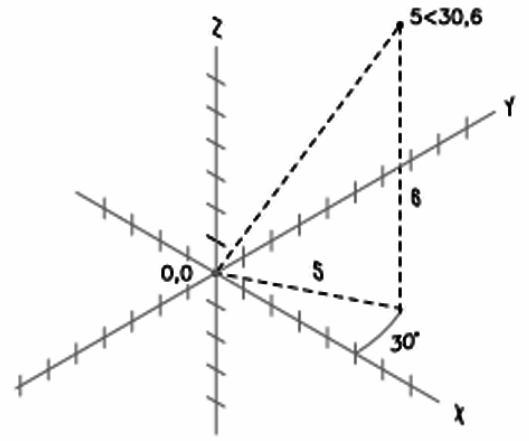
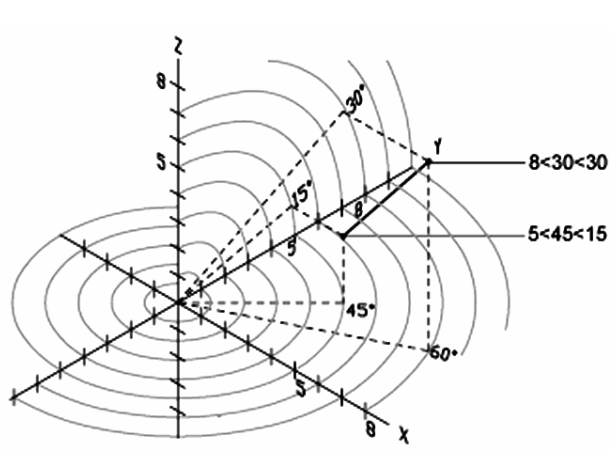

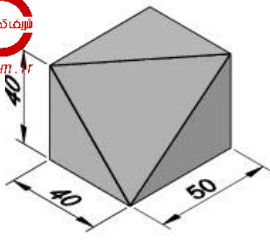

شکل ۲۸-۴

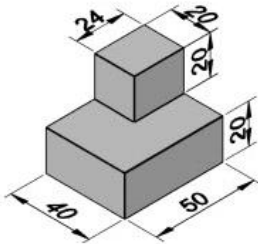

شکل ۲۷-۴

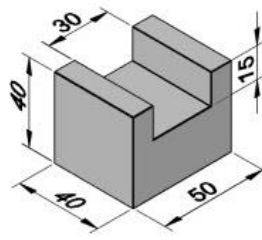

شکل ۲۶-۴

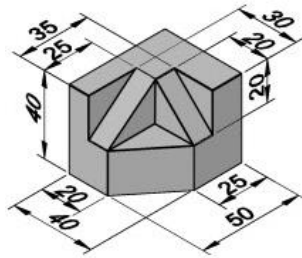

شکل ۳۱-۴

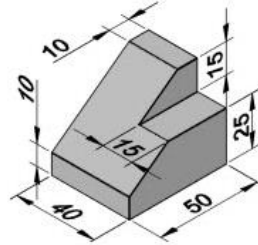

شکل ۳۰-۴

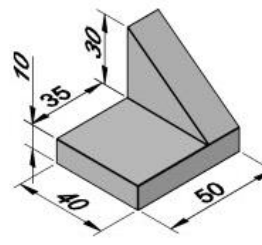

شکل ۲۹-۴

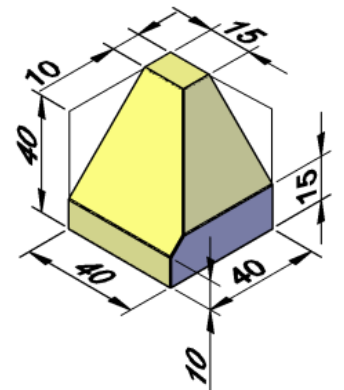
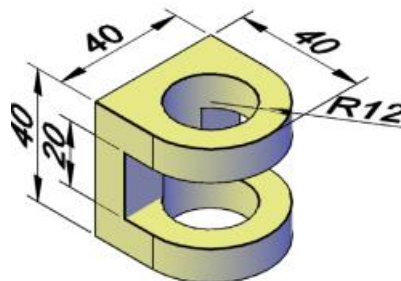
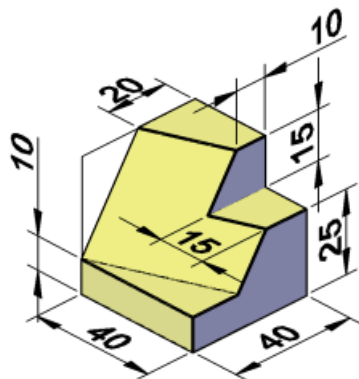
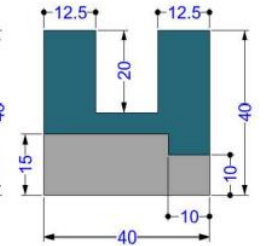
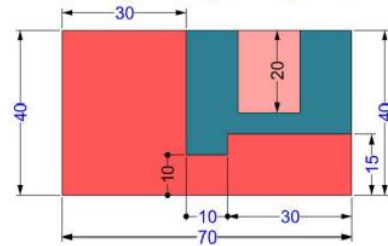
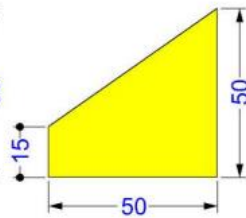
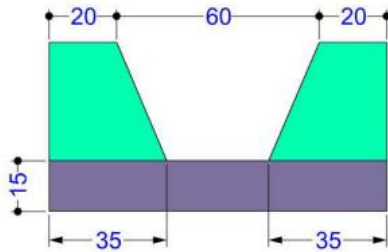
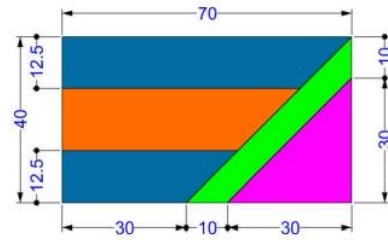
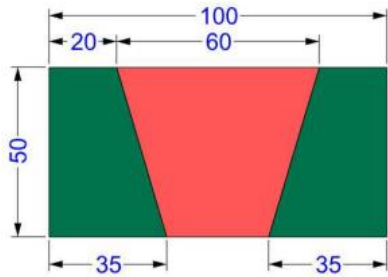
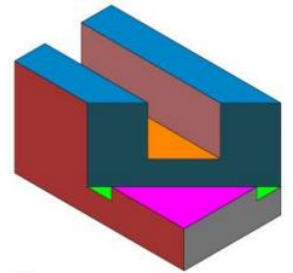
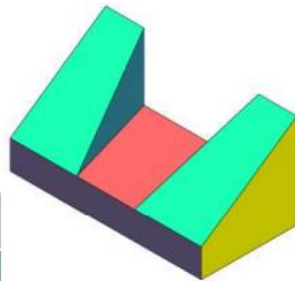
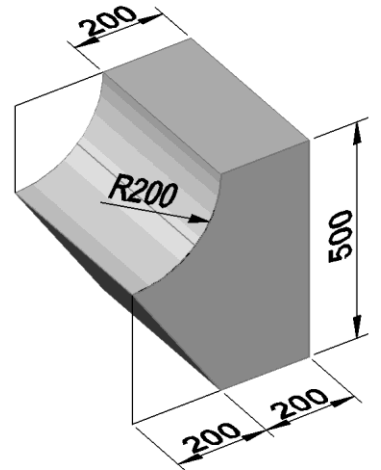

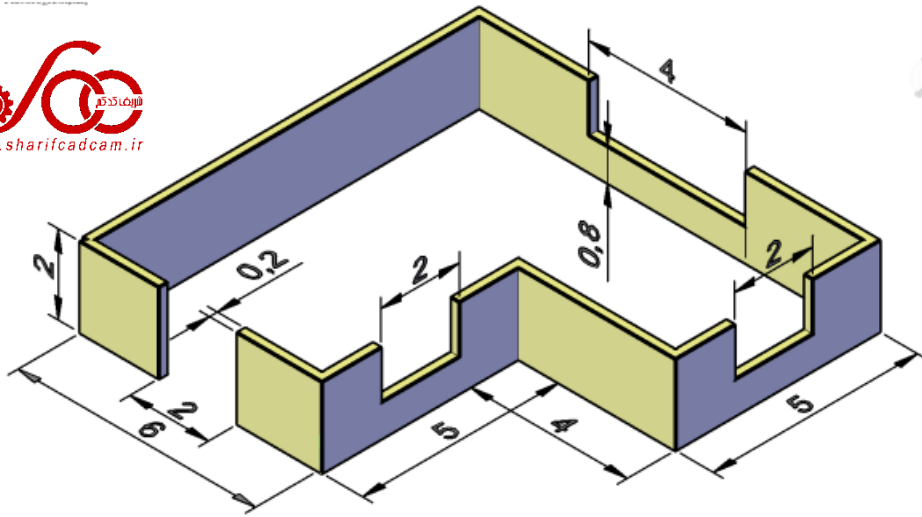

شکل ۴-۱۵

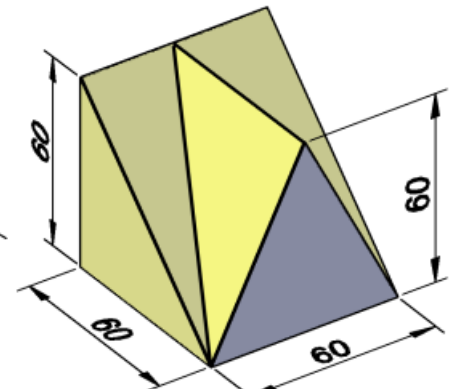

شکل ۴-۲۳

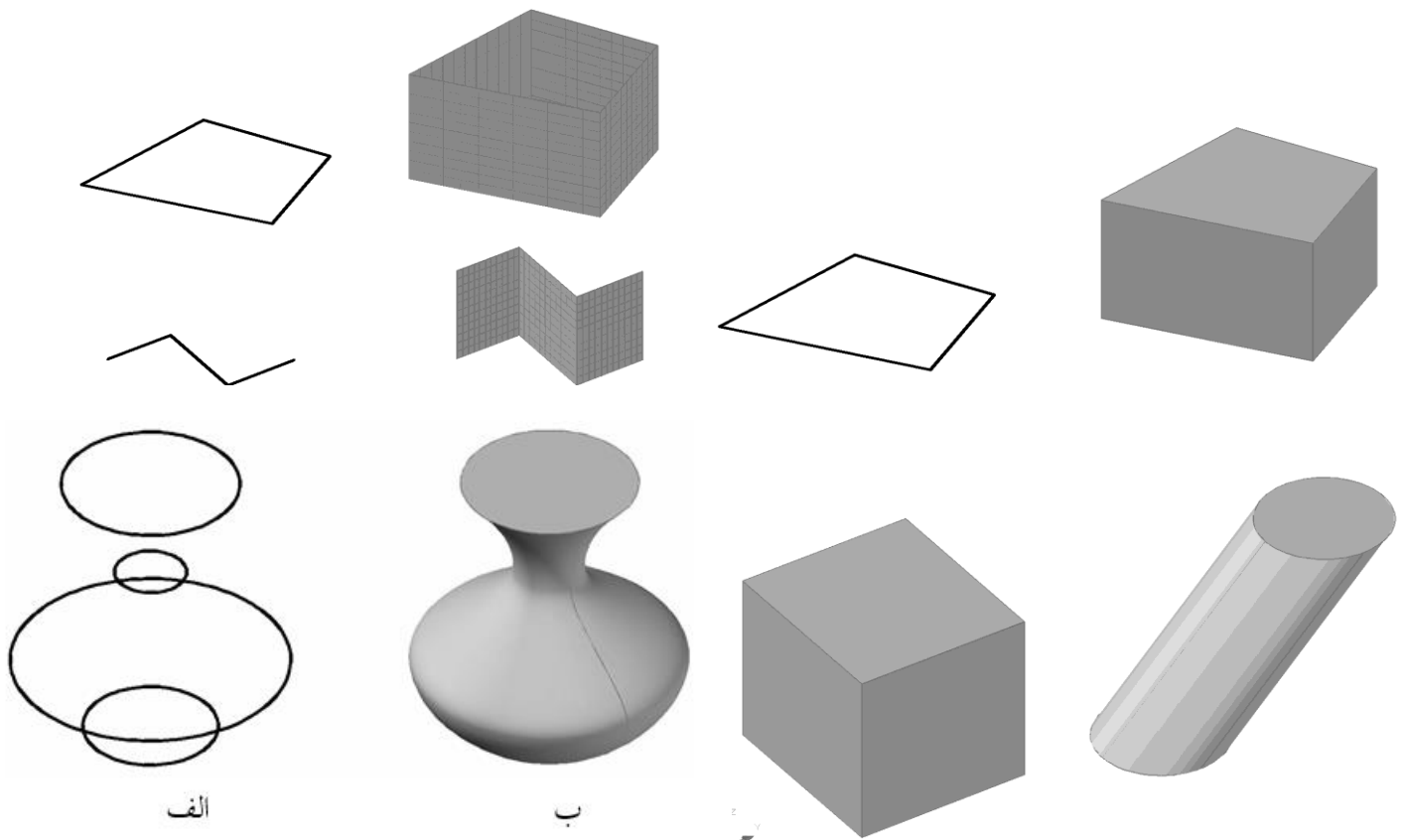

الف

ب



شکل ۷۱

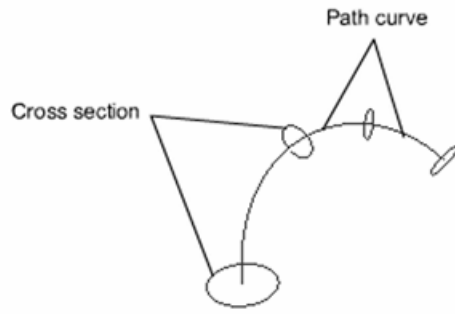

شکل ۷۰

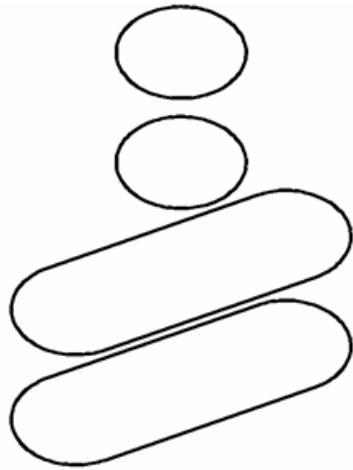

شکل ۷۴

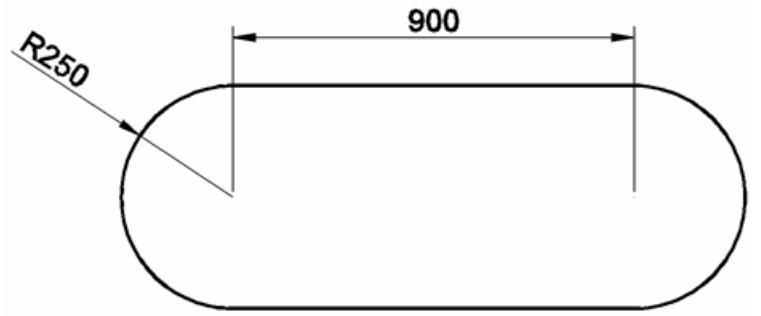

شکل ۷۲

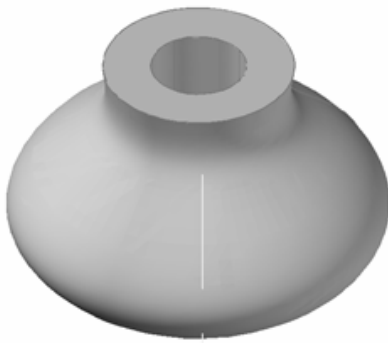

ج



ب

شکل ۷۵

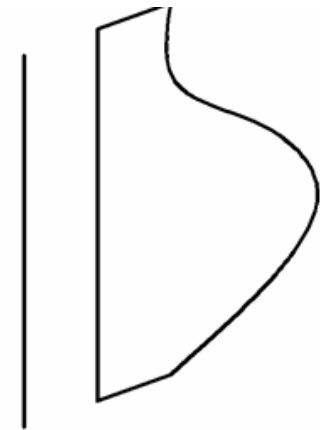

الف

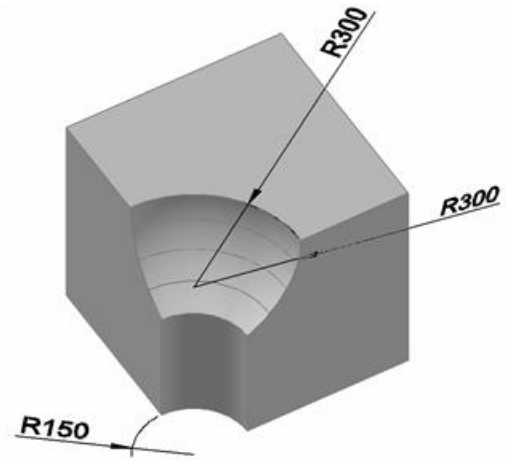
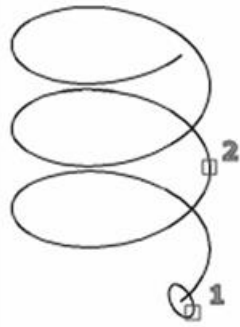
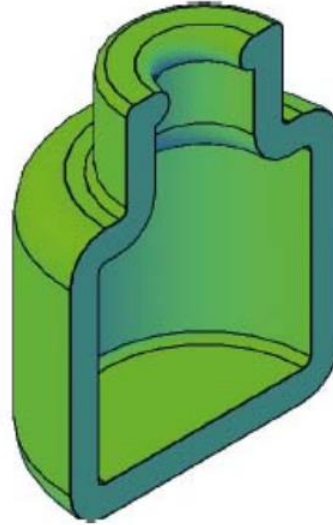
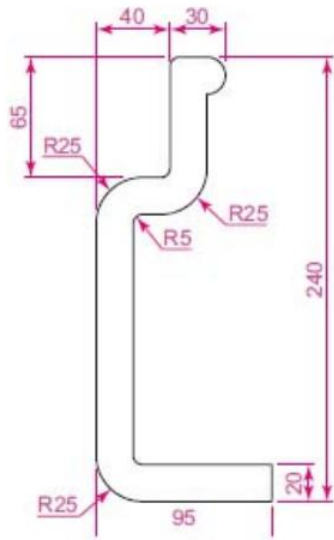

شکل ۸۱

شکل ۷۸

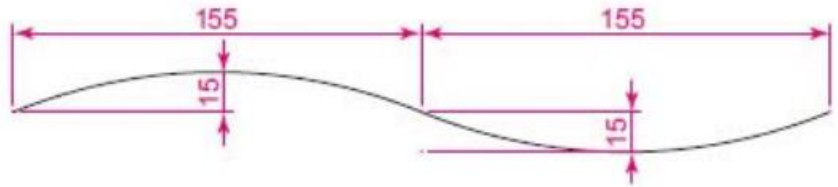
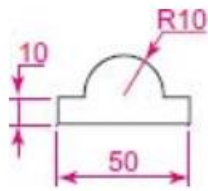

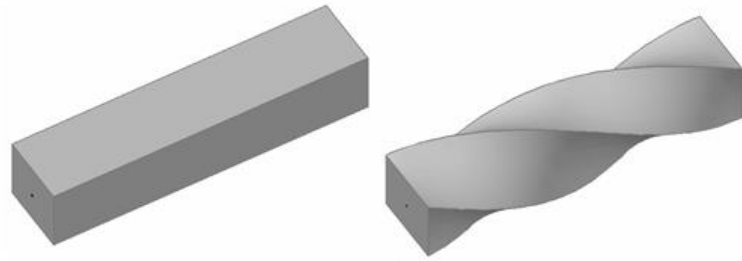

شکل ۸۳



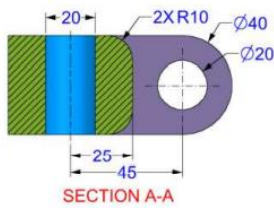
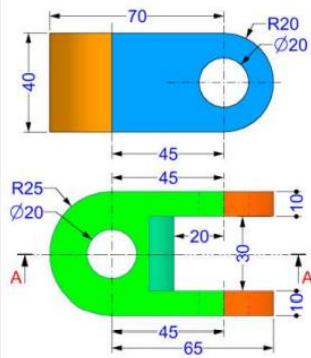
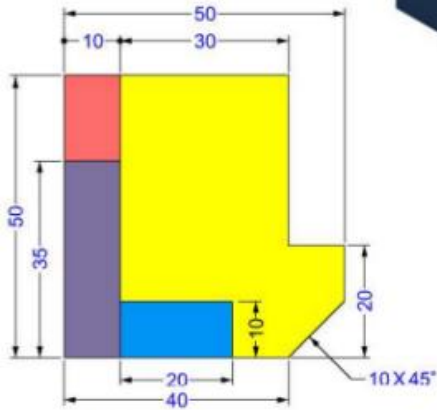
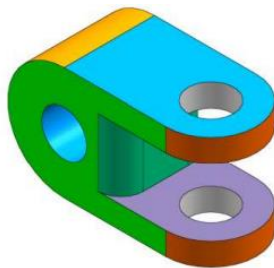
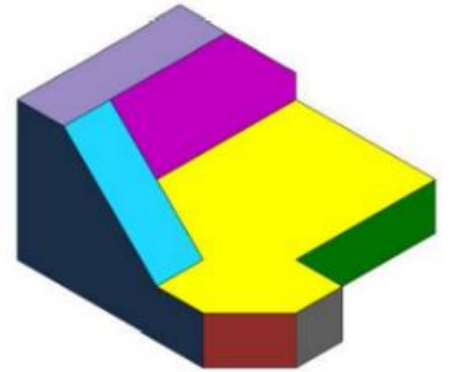
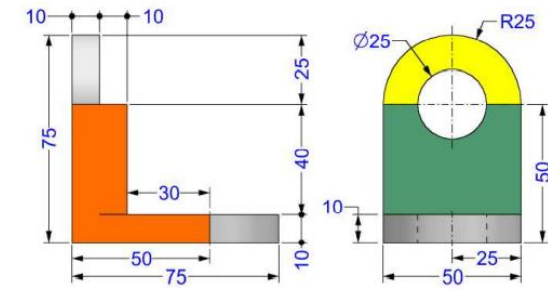
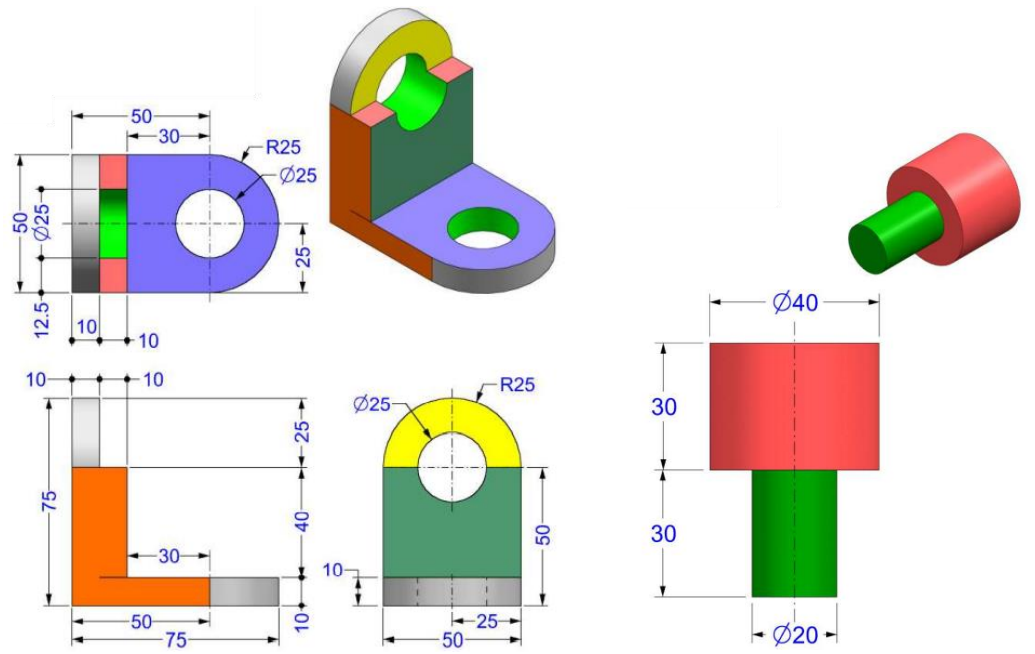

SECTION A-A

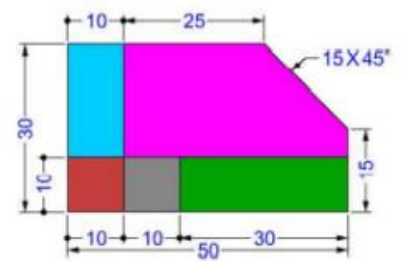
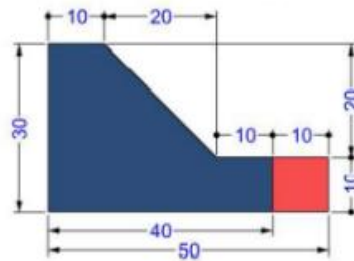

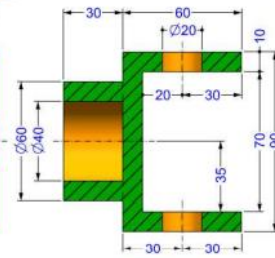
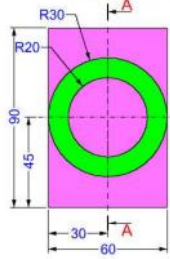
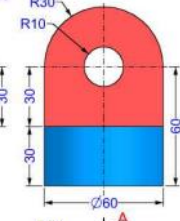
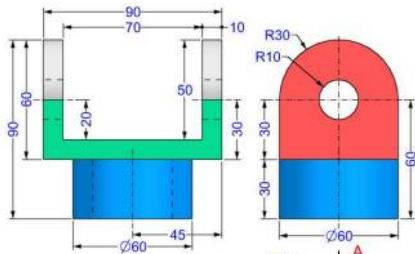

SECTION A-A

