



دوره آموزشی

اینونتور Inventor

مقدماتی

مهدی متقی پور

عضو هیأت علمی دانشگاه صنعتی شریف

Www.sharifcadcam.ir

Sharifcadcam@gmail.com

@sharifcadcam

021-66980854

021-66980926

این جزوه متعلق به موسسه شریف کد کم می باشد. کپی و نشر تمام و یا بخشی از آن غیر قانونی است.

تنها افرادی مجاز به استفاده از این جزوه هستند که دوره آموزشی اینونتور مقدماتی را از سایت sharifdoreh.com خریداری کرده اند.

جزوه جلسه چهارم

# A0 (841x1189)



ALL DIMENSION IN MM

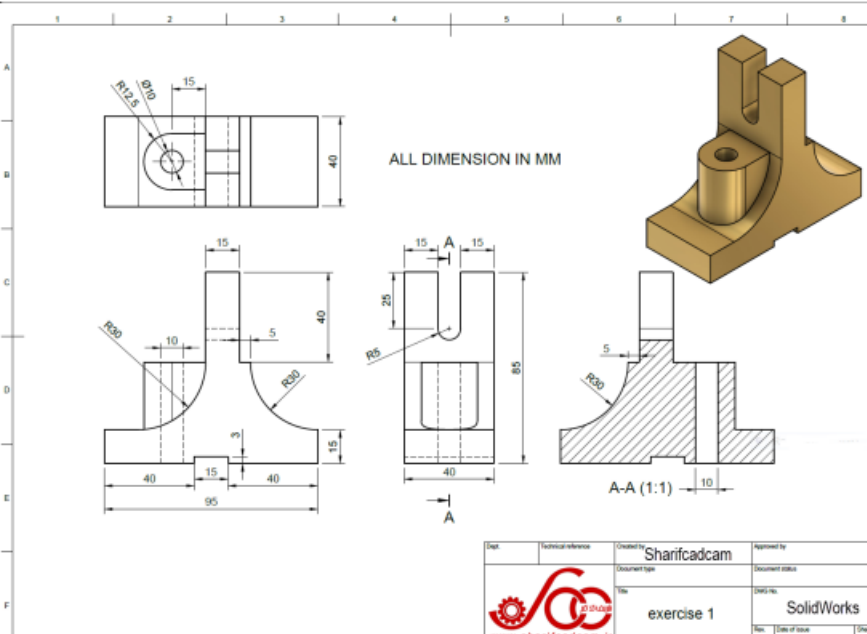

Dept.	Technical reference	Created by	Sharifcadcam	Approved by
		Document type		Document status
		Title	exercise 1	Drawn by
				SolidWorks
		Rev.	001 of 001	Sheet
				1/1

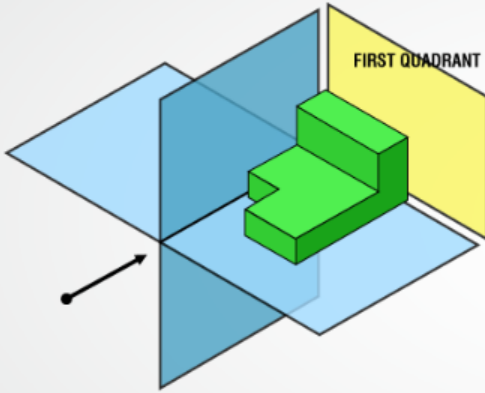

### FIRST ANGLE SYSTEM

- EUROPEAN COUNTRIES
- ISO STANDARD
- PLANES ARE OPAQUE

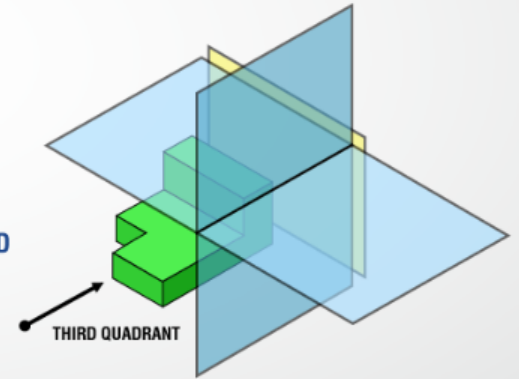

### THIRD ANGLE SYSTEM

- CANADA, USA, JAPAN, THAILAND
- PLANES ARE TRANSPARENT

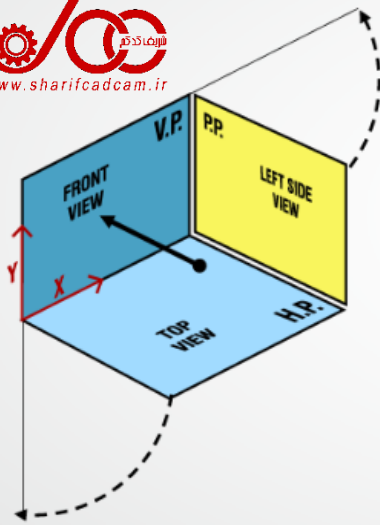

- CONSIDER THAT THE ARROW DIRECTION IS THE NORMAL DIRECTION OF OBSERVING THE OBJECT.
- BUT IN THIS DIRECTION ONLY V.P. AND FRONT VIEW ON V.P. CAN BE SEEN.
- THE OTHER PLANES AND VIEWS ON THOSE CAN NOT BE SEEN.

### TO MAKE THOSE PLANES ALSO VISIBLE FROM THE ARROW DIRECTION:

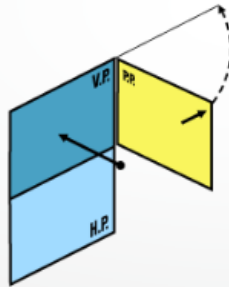

STEP 1  
HP IS ROTATED 90° DOWNWARD

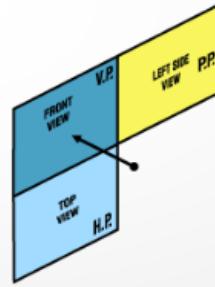

STEP 2  
PP IS ROTATED 90° IN RIGHT SIDE

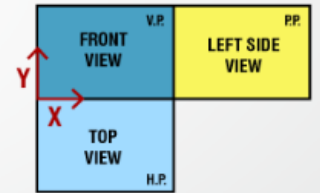

THIS WAY BOTH PLANES ARE BROUGHT IN THE SAME PLANE CONTAINING VP.

## FIRST ANGLE SYSTEM

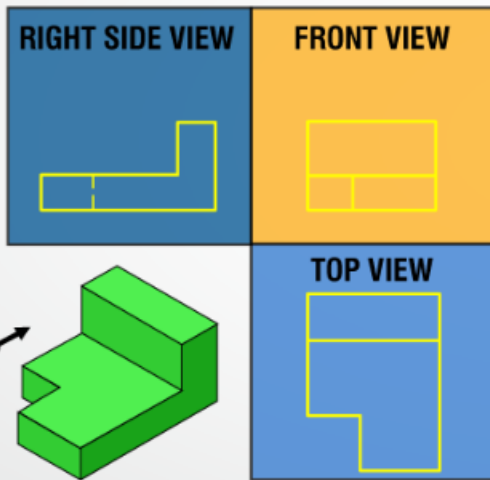

## THIRD ANGLE SYSTEM

